



PABLO multilens

track

EN Track light made of die-cast aluminium; powder coated; 360° rotatable and 310° tiltable; converter installed in aluminium spotlight housing; COB (Chip on Board) technology for maximum efficiency; no multiple shadows; energy-eff. LEDs – very good colour rendering; exchangeable additional lenses; precise radiation characteristics with different beam angles; installed and exchanged without tools; optical attachments as accessories; adapter for toolless insertion or movement on a variety of 3-phase power tracks; adapter fixation optionally without tools by means of knurled screw or set screw (screwdriver required); point outlet, either in surface mounted housing or recessed housing, as an accessory

IT Faretto da binario elettrificato in alluminio pressofuso; verniciatura a polvere; girevole 360° e orientabile 310°; converter integrato nel telaio di alluminio del faretto; con tecnologia COB (Chip on Board) per la massima efficienza; assenza di ombre multiple; LED a risp. energ. – ottima resa cromatica; lenti addiz. intercambiabili; curva fotometrica precisa con diversi angoli di emissione; montaggio e smontaggio senza utensili; unità ottiche come accessori; adattatore per installazione senza utensili o scorrimento in vari binari trifase; fissaggio adattatore a scelta senza attrezzi mediante vite a testa zigrinata o vite di serraggio (cacciavite necessario); allacciamento singolo con armatura a plafone o da incasso, come accessorio

Quickinfo

3000K, 4000K
CRI ≥ 90, 2 SDCM
up 76lm/W
L85 @ 50000h
DIM POTI

Type

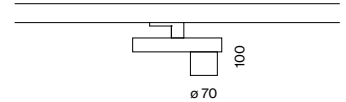

Colours



Light distributions



DiiA® standards
251, 252, 253



interchangeable
diffusion sheets



360° rotatable
310° tiltable



DIM POTI/
rotation lock

Order options

ADAPTER FIXATION

tool-free fixation	2
set screw (tool required)	1

COLOUR TEMPERATURE

3000K	5
4000K	6

CONTROL

DIM POTI

MATERIAL COLOUR

<input type="radio"/> traffic white RAL 9016	7
<input checked="" type="radio"/> jet black RAL 9005	8

BEAM ANGLE

10/19/30/38/40/64°

Options on request

CONTROL

DALI-2

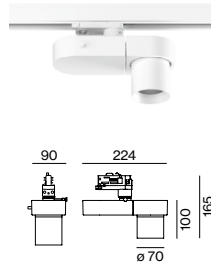

PABLO multilens 10–60°



TRACK LIGHT

SYS. POWER	COLOUR TEMPERATURE	LUMINOUS FLUX	ORDER CODE
14.8W	3000K	1050lm	1 8 0 - 5 7 0 0 :: 8 
	4000K	1130lm	

incl. 5 pcs. interchangeable diffusion sheets



Optical accessories

OVAL FILTER

TYPE	ORDER CODE
oval filter 60 × 15°	0 8 0 - 5 9 0 0 0 2 0
diffusion sheet for superspot*	0 8 0 - 5 9 0 0 0 3 0

*for a better homogeneous illumination

Mounting accessories

SURFACE HOUSING/POINT OUTLET

TYPE	ORDER CODE
surface housing/point outlet	1 8 6 - 0 7 2 2 8 

RECESSED HOUSING/POINT OUTLET

ceiling thickness: 1-30 mm

TYPE	ORDER CODE
recessed housing/point outlet	1 8 6 - 0 7 2 2 7 

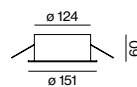



Types

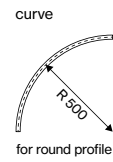
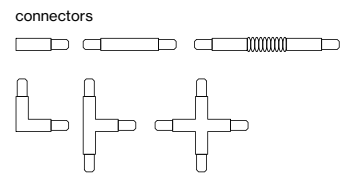
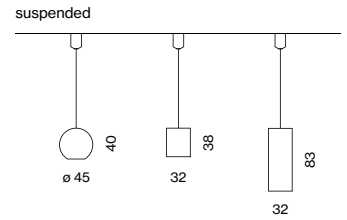
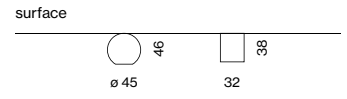
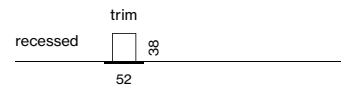

Colours



TRACK 3-phase
recessed/surface/suspended



curve connector



optimised adapter integration

TRACK recessed

Order options

CONTROL

non DIM

DALI-2

MATERIAL COLOUR

- pure white RAL 9010 7
- jet black RAL 9005 8

Pole options

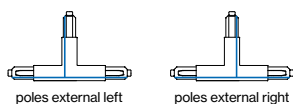
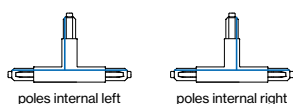

TRACK 3-phase/3-phase + DALI-2-bus



TRACK 240V-16A

L (mm)	ORDER CODE
2000	186-012213
3000	186-012313
4000	186-012413

end cap 186-022011

end feed left 186-022313
 end feed right 186-022413
 middle feed 186-021323

CONNECTORS 240V-16A

TYPE **ORDER CODE**
 linear connector 186-021113

I-connector 186-022123

L-connector right 186-022133
 L-connector left 186-022233

T-connector right (poles internal) 186-022143
 T-connector left (poles internal) 186-022243
 T-connector right (poles external) 186-022173
 T-connector left (poles external) 186-022273

X-connector 186-022153

MOUNTING ACCESSORIES

TYPE **ORDER CODE**
 clip 186-0225110

cutting tool 186-0219110

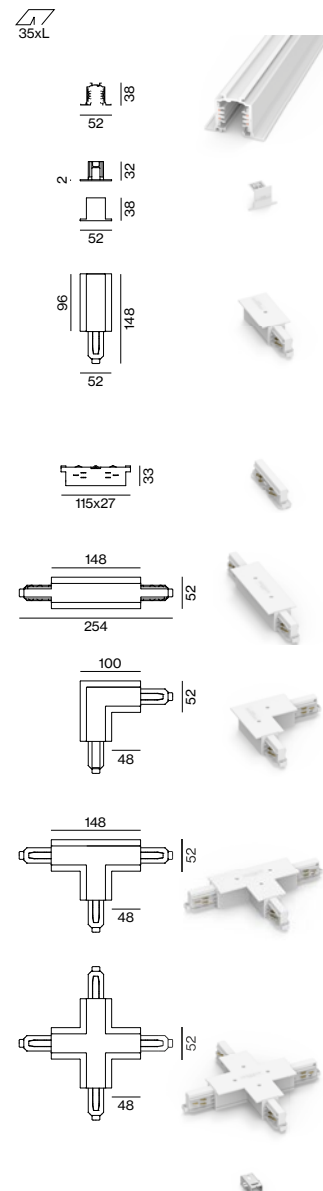

TRACK

surface/suspended

Order options

CONTROL

non DIM
 DALI-2

MATERIAL COLOUR

- pure white RAL 9010 7
- white aluminium RAL 9006 6
- jet black RAL 9005 8

Pole options

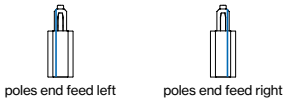
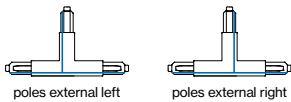
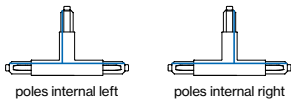

TRACK 3-phase/3-phase + DALI-2-bus



TRACK 240V-16A

L (mm)	ORDER CODE
1000	186-011123
2000	186-011223
3000	186-011323
4000	186-011423

end cap 186-021011

end feed left 186-021313
 end feed right 186-021413
 middle feed* 186-021323

*only available in white and black

CONNECTORS 240V-16A

TYPE ORDER CODE
 linear connector 186-021113

I-connector 186-021123

L-connector right 186-021133

L-connector left 186-021233

T-connector right (poles internal) 186-021143

T-connector left (poles internal) 186-021243

T-connector right (poles external) 186-021173

T-connector left (poles external) 186-021273

X-connector 186-021153

adjustable corner connector 186-021163

MOUNTING ACCESSORIES

TYPE ORDER CODE
 ceiling clip 186-021511

pendant clip cable 186-021521

pendant clip rod 186-021541

joiner piece cable 186-021531

joiner piece rod 186-021551

cutting tool 186-0219110

SUSPENSION KIT

TYPE ORDER CODE
 pendant 1000 186-021611

cable 1500 186-0217110

cable 3000 186-0217210

cable 6200 186-0217310

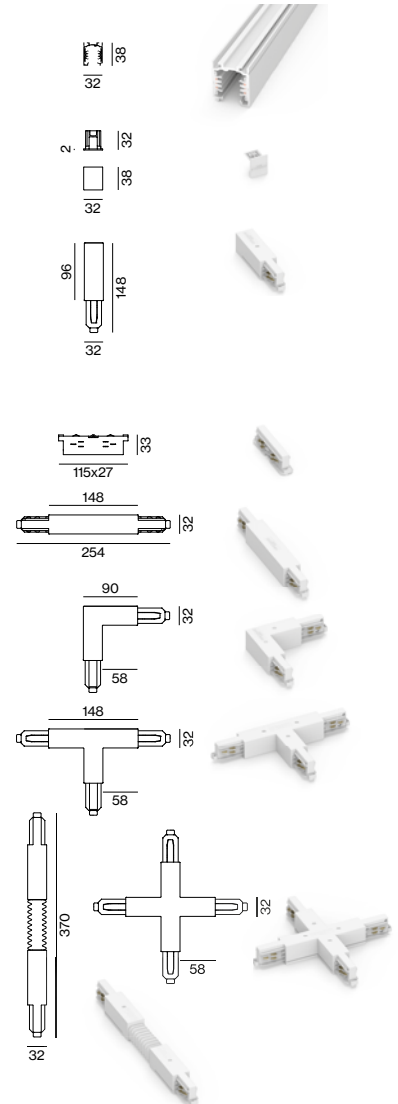

TRACK high

surface/suspended

Order options

CONTROL

non DIM

DALI-2

MATERIAL COLOUR

- pure white RAL 9010 7
- jet black RAL 9005 8

Options on request

LIGHT OPTIC COVER

inset indirect

Pole options

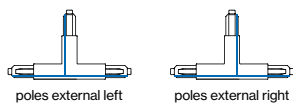
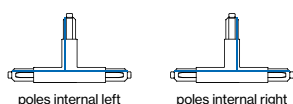

TRACK high 3-phase/3-phase + DALI-2-bus



TRACK 240V-16A

L (mm)	ORDER CODE
1000	186-016113
2000	186-016213
3000	186-016313
4000	186-016413

end cap 186-026011

end feed left 186-026313

end feed right 186-026413

middle feed 186-021323

CONNECTORS 240V-16A

TYPE **ORDER CODE**

linear connector 186-026113

L-connector 186-026123

L-connector right 186-026133

L-connector left 186-026233

T-connector right (poles internal) 186-026143

T-connector left (poles internal) 186-026243

T-connector right (poles external) 186-026173

T-connector left (poles external) 186-026273

X-connector 186-026153

MOUNTING ACCESSORIES

TYPE **ORDER CODE**

pendant clip cable 186-0265210

pendant sheet metal clip 186-0215220

pendant clip rod 186-0265410

joiner piece cable 186-0265310

joiner piece rod 186-0265510

cutting tool 186-0219110

SUSPENSION KIT

TYPE **ORDER CODE**

pendant 1000 186-0216110

cable 1500 186-0217110

cable 3000 186-0217210

cable 6200 186-0217310

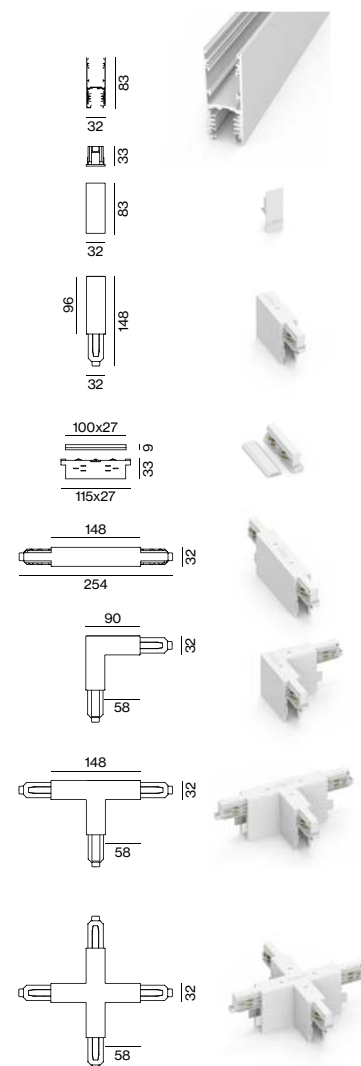

TRACK round surface/suspended

Order options

CONTROL

non DIM
DALI-2

MATERIAL COLOUR

○ pure white RAL 9010 7
● jet black RAL 9005 8

Options on request

CONNECTOR

T-connector
X-connector

TRACK round 3-phase/3-phase + DALI-2-bus



TRACK 240V-16A

L (mm)	ORDER CODE
1000	186-015113
2000	186-015213
3000	186-015313
4000	186-015413

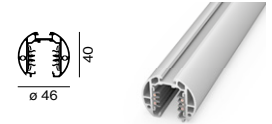

TRACK CURVE 240V-16A

TYPE	ORDER CODE
R 500 90° left	186-015853
R 500 90° right	186-015863

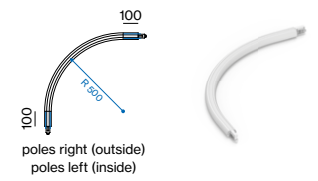

end cap 186-025011



end feed left 186-025313
end feed right 186-025413
middle feed 186-021323



CONNECTORS 240V-16A

TYPE	ORDER CODE
linear connector	186-021113
L-connector right	186-025133
L-connector left	186-025233

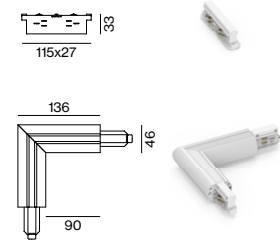

MOUNTING ACCESSORIES

TYPE	ORDER CODE
pendant clip cable	186-025521
pendant clip rod	186-025541
joiner piece cable	186-025531
joiner piece rod	186-025551
cutting tool	186-0219110

SUSPENSION KIT

TYPE	ORDER CODE
pendant 1000	186-021611
cable 1500	186-0217110
cable 3000	186-0217210
cable 6200	186-0217310